

PLAN

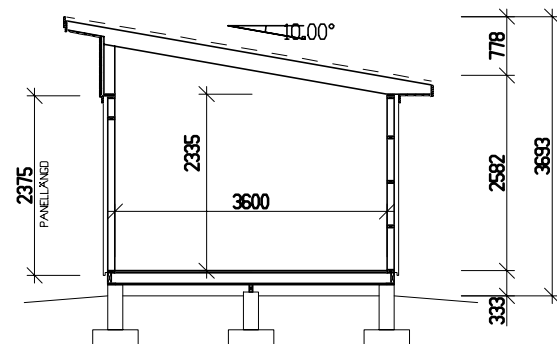

SEKTION

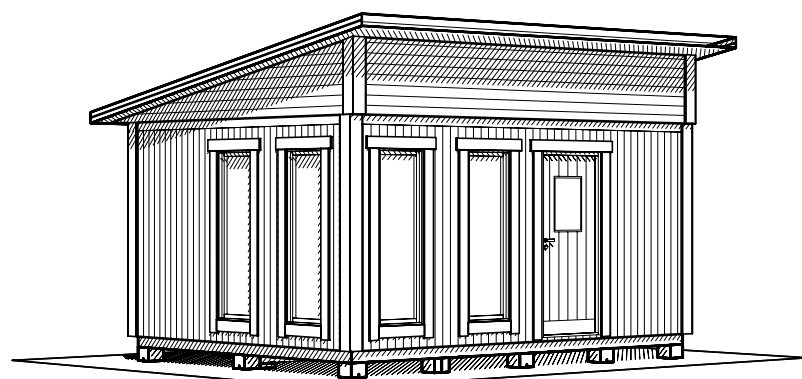

PERSPEKTIV

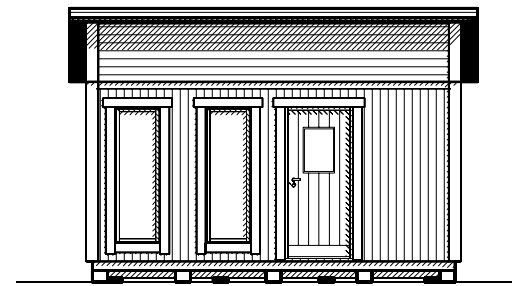
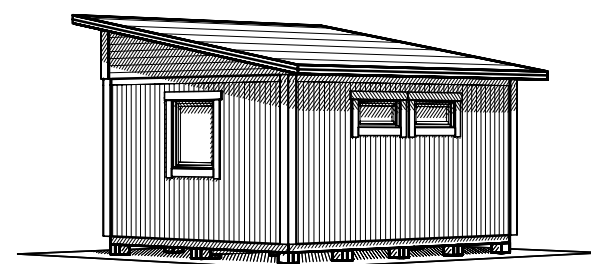

FASAD MOT

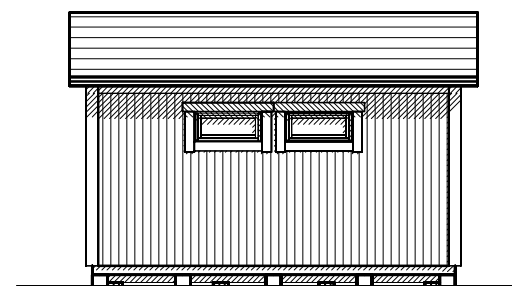

FASAD MOT

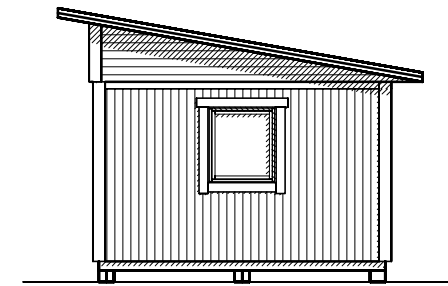

FASAD MOT

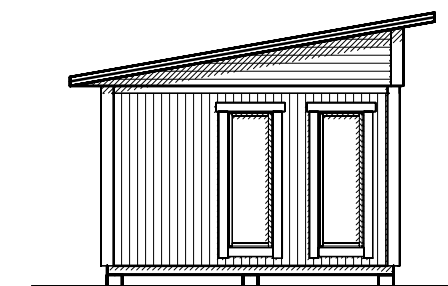

FASAD MOT

PANEL: FUNKISPANEL 22x120.
 STOMME: 34x95.
 OISLERAT.
 BJÄKLÄG 45x145.
 GRUNDLÄGGNING: PLINT GRUND.
 LEVERANSOMFATTNING ENLIGT AVTAL.

| BET | ANT | ÄNDRINGEN AVSER | DATUM | SIGN |
|-----|-----|-----------------|-------|------|
|-----|-----|-----------------|-------|------|

BYGGLOVSHANDLING
 NYBYGGNAD AV KOMPLEMENTBYGGNAD



| | |
|-----------------------------|-----------------------|
| UPPDRAG NR/RITN. NR XXXX | RITAD/KONSTR AV PH |
| DATUM 2018-11-02 | HANDLÄGGARE |

PLAN & SEKTION
 NJUTA FUNKIS 20-4

| | | | |
|----------|--------------------|---------------|-----|
| ANSVARIG | SKALA 1:100, A3 | NUMMER A01 | BET |
|----------|--------------------|---------------|-----|